

Technical Drawings and Circuit Diagrams



Technical Specifications

Switch

Circuit Diagram

- Controls a lamp or a lamp group from a point.
- 16AX, 250V~
- One-way
- Screw connection

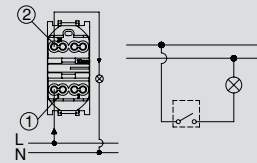
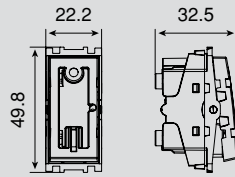

Technical Specifications

One-Way Switch, Illuminated

Circuit Diagram

- Controls a lamp or a lamp group from a point.
- 16AX, 250V~
- One-way
- Illuminated indicator
- Screw connection

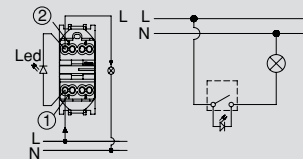
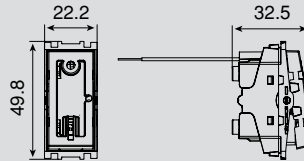

Technical Specifications

Two-Way Switch

Circuit Diagram

- Controls a lamp or a lamp group from two different points.
- 16AX, 250V~
- Two-way
- Screw connection

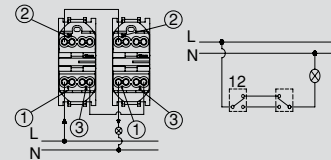
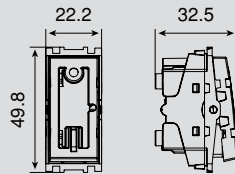

Technical Specifications

Two-Way Switch, Illuminated

Circuit Diagram

- Controls a lamp or a lamp group from two different points.
- 16AX, 250V~
- Two-way
- Illuminated indicator
- Screw connection

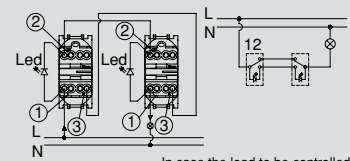
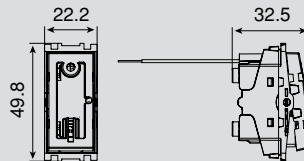

In case the load to be controlled by the product is a load generating in-rush like LED lamp and CFL lamp, please read the warnings part.



Technical Specifications

Intermediate Switch

Circuit Diagram

- Controls a lamp or a lamp group from more than two points.
- 16AX, 250V~
- Two-way
- Screw connection

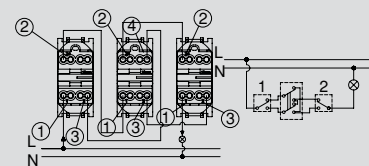
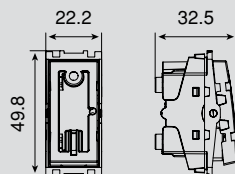

Technical Specifications

Intermediate Switch, Illuminated

Circuit Diagram

- Controls a lamp or lamp group from more than two points.
- 16AX, 250V~
- Two-way
- Illuminated indicator
- Screw connection

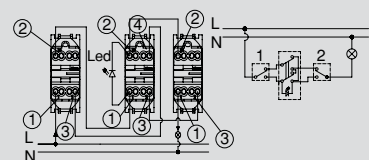
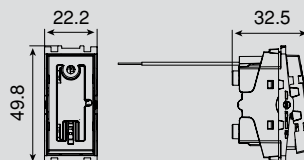

Technical Specifications







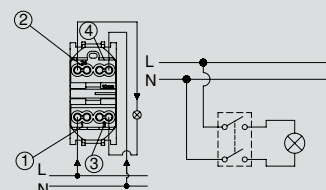
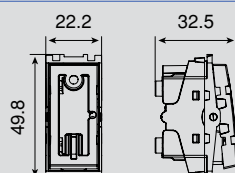



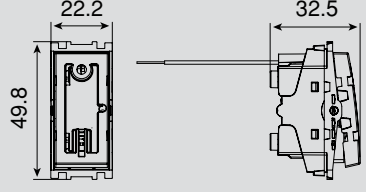
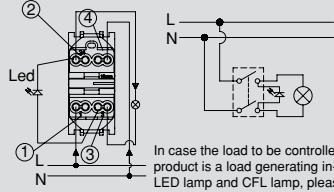

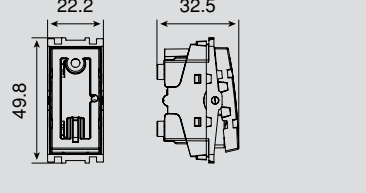
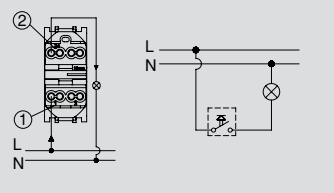
Two-Pole Switch

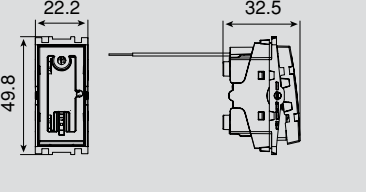
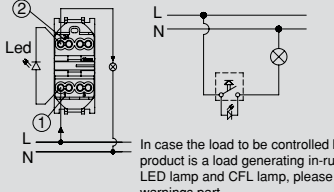
Circuit Diagram

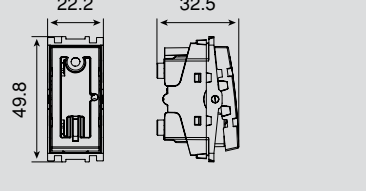
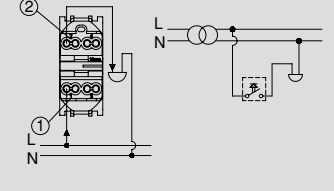
- Two poles enable simultaneous disconnection of switches, phase and neutral.
- 16AX, 250V~
- Double pole, one-way
- Screw connection

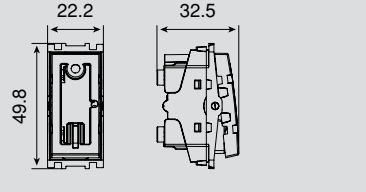
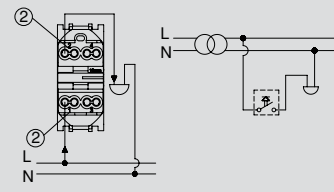

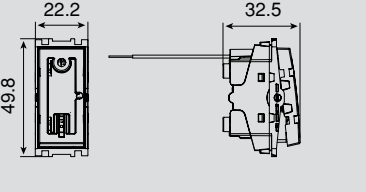
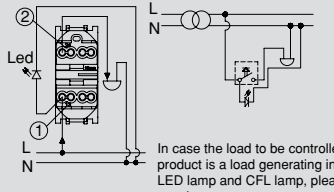
Technical Drawings and Circuit Diagrams

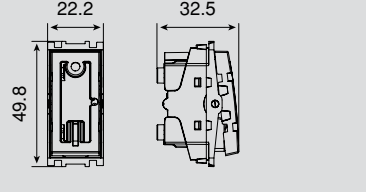
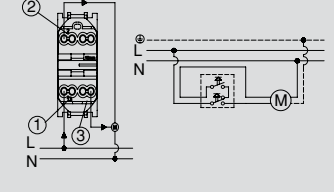
	Technical Specifications	Two-Pole Switch, Illuminated	Circuit Diagram
	<ul style="list-style-type: none"> • Two poles enable simultaneous disconnection of switches, phase and neutral. • 16AX, 250V~ • Double pole, single way • Illuminated indicator • Screw connection 		 <p>In case the load to be controlled by the product is a load generating in-rush like LED lamp and CFL lamp, please read the warnings part.</p>
	Technical Specifications	One-Way Push Button	Circuit Diagram
	<ul style="list-style-type: none"> • Generates control signals for external trigger circuits such as building lights with automatic timer, motion detector or automated system. • 16A, 250V~ • One-way • Push button, instant trigger • Screw connection 		
	Technical Specifications	One-Way Push Button, Illuminated	Circuit Diagram
	<ul style="list-style-type: none"> • Generates control signals for external trigger circuits such as building lights with automatic timer, motion detector or automated system. • 16A, 250V~ • One-way • Push button, instant trigger • Illuminated indicator • Screw connection 		 <p>In case the load to be controlled by the product is a load generating in-rush like LED lamp and CFL lamp, please read the warnings part.</p>
	Technical Specifications	Push Button with Key Symbol	Circuit Diagram
	<ul style="list-style-type: none"> • Generates control signals for external trigger circuits such as building lights with automatic timer, motion detector or automated system. • 10A, 250V~ • One-way • Push button, instant trigger • Screw connection 		
	Technical Specifications	Push Button with Bell Symbol	Circuit Diagram
	<ul style="list-style-type: none"> • Controls the door bell. • 10A, 250V~ • One-way • Push button, instant trigger • Screw connection 		
	Technical Specifications	Push Button with Bell Symbol, Illuminated	Circuit Diagram
	<ul style="list-style-type: none"> • Controls the door bell. • 10A, 250V~ • Push button, instant trigger • Illuminated indicator • Screw connection 		 <p>In case the load to be controlled by the product is a load generating in-rush like LED lamp and CFL lamp, please read the warnings part.</p>
	Technical Specifications	Shutter Control Switch	Circuit Diagram
	<ul style="list-style-type: none"> • Controls up and down movement of shutters, by controlling shutter motors via single button • 10AX, 250V~ • Two way, three positions • Screw connection 		

Technical Drawings and Circuit Diagrams



Technical Specifications

Emergency Push Button with Cord

Circuit Diagram

- Generates control signals for external trigger circuits such as building lights with automatic timer, motion detector or automated system.
- 10AX, 250V~
- One-way
- Push button, instant trigger
- Screw connection

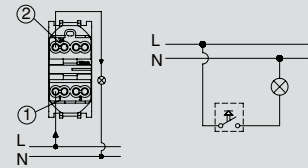
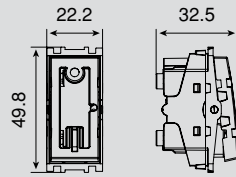

Technical Specifications

Double One-way Push Button

Circuit Diagram

- Generates two different control signals for external trigger circuits such as motion detectors or automated systems.
- Two independent phase inputs allow connection of multiple different phases.
- 10AX, 250V~
- Double pole, single way
- Screw connection

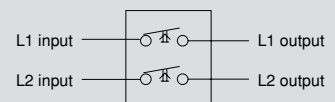
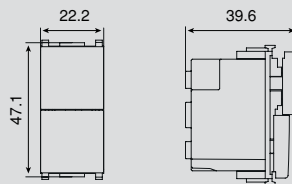

Technical Specifications

Pro Dimmer R 300W 1M

Circuit Diagram

- R type dimmer
- 300W maximum output power (R type load)
- 20W minimum output power
- Feature to use as two-way
- Feature to switch on/off at the set level of dimming.

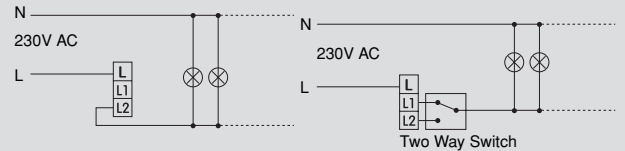
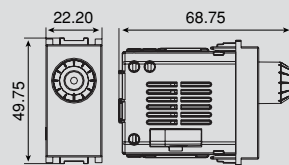

Technical Specifications

Pro Dimmer R 6-100W/VA

Circuit Diagram

- R type dimmer
- 100W maximum output power (R type load)
- 6W minimum output power
- Feature to use as two-way
- Feature to switch on/off at the set level of dimming.

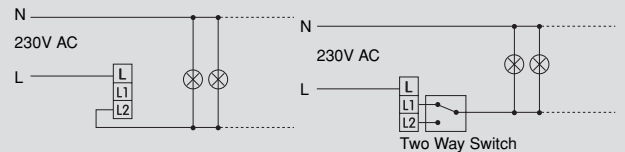
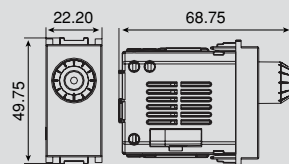

Technical Specifications

Pro Dimmer RC 20-300W/VA

Circuit Diagram

- RC type dimmer
- 300W maximum output power (R type load) 300VA maximum output power 300VA (C type load)
- 20W minimum output power
- Feature to use as two-way
- Feature to switch on/off at the set level of dimming.

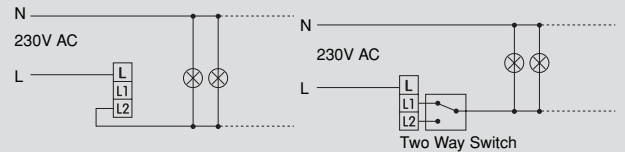
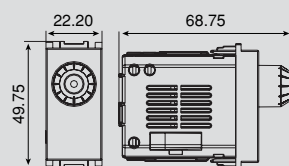

Technical Specifications







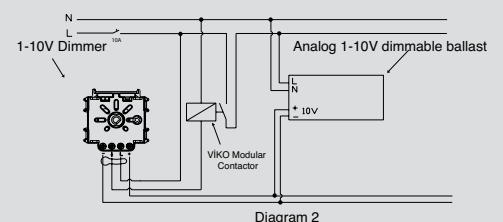
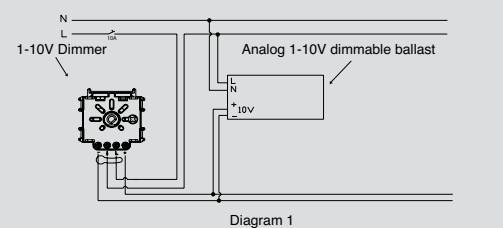
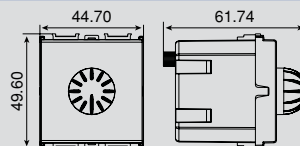



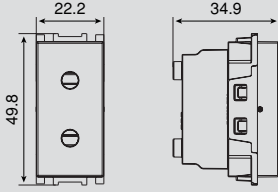
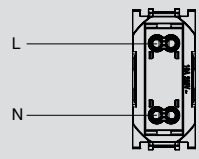

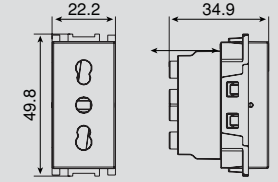
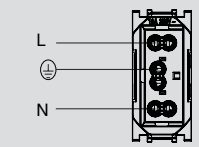
Rotary Dimmer 1-10V

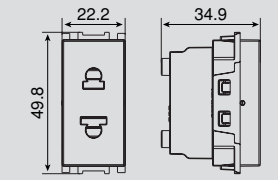
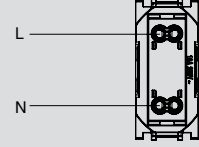
Circuit Diagram

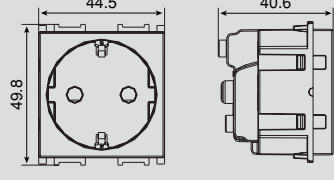
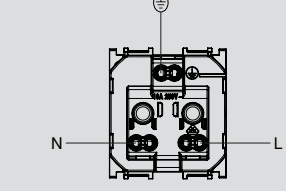

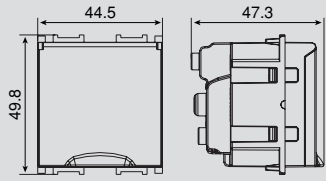
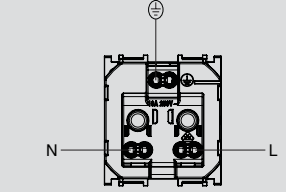

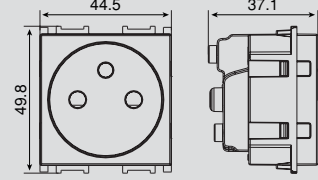
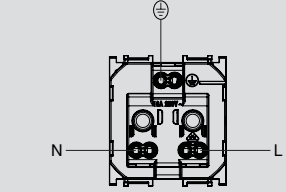

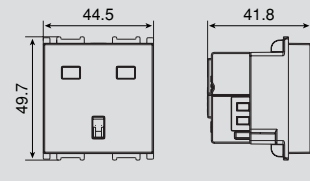
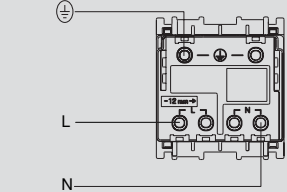

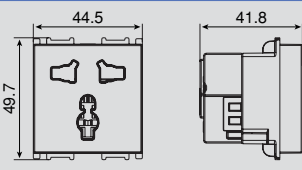
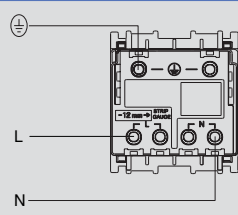

- Operating temperature +5°C...+35°C
- 0,8V...11V control voltage
- Control current 50mA
- Switching current 5AX
- Fuse 500mAh

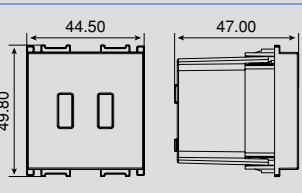
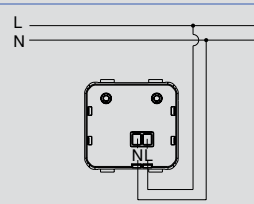

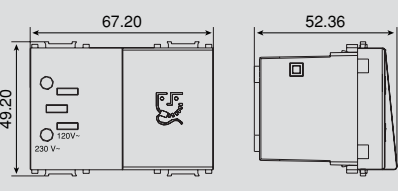
Technical Drawings and Circuit Diagrams

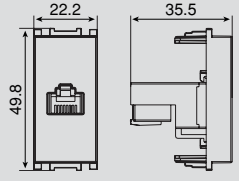
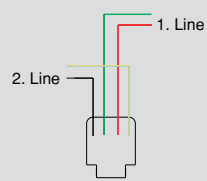
	Technical Specifications	Socket 2P, Child Protection	Circuit Diagram
	<ul style="list-style-type: none"> • 16A, 250V~ • 2P • Child protection • Screw connection 		
	Technical Specifications	Italian Type Socket	Circuit Diagram
	<ul style="list-style-type: none"> • 13A-16A • 2P+E • Child protection • Screw connection 		
	Technical Specifications	Euro-American Socket	Circuit Diagram
	<ul style="list-style-type: none"> • 13A-16A • 2P • Child protection option • Screw connection 		
	Technical Specifications	Socket 2P+E, Child Protection	Circuit Diagram
	<ul style="list-style-type: none"> • 16A, 250V~ • 2P+E • Child protection • Screw connection 		
	Technical Specifications	Socket 2P+E with Lid, Child Protection	Circuit Diagram
	<ul style="list-style-type: none"> • 16A, 250V~ • 2P+E • Child protection • Screw connection 		
	Technical Specifications	Socket 2P+E French Type, Child Protection	Circuit Diagram
	<ul style="list-style-type: none"> • 16A, 250V~ • 2P+E • Child protection • Screw connection 		
	Technical Specifications	Socket 2P+E British Type, Child Protection	Circuit Diagram
	<ul style="list-style-type: none"> • 6A-10A-13A • 2P+E • Child protection • Screw connection 		

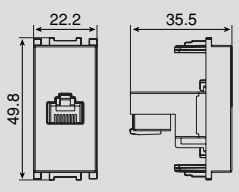
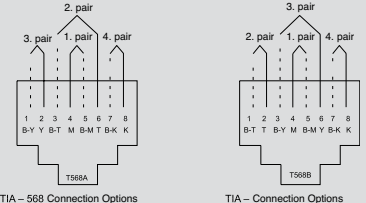
Technical Drawings and Circuit Diagrams

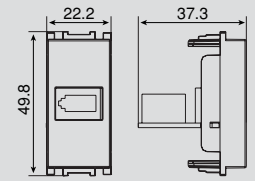
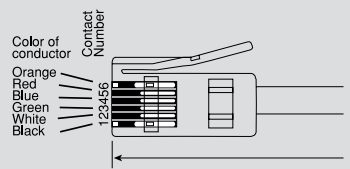
	Technical Specifications	Combi Socket	Circuit Diagram
	<ul style="list-style-type: none"> • 6A-10A-13A • 2P+E • Child protection • Screw connection 		
	Technical Specifications	USB Socket	Circuit Diagram
	<ul style="list-style-type: none"> • 1A, 250V~ • 5VDC output voltage • Operating temperature +10°C...+55°C • Child protection • Screw connection 		
	Technical Specifications	Shaver Socket	Circuit Diagram
	<ul style="list-style-type: none"> • 230V~, 50/60Hz • 230V~/ 120V~ output voltage • 20VA maximum load • IP21 protection class 		
	Technical Specifications	Phone Socket (RJ11)	Circuit Diagram
	<ul style="list-style-type: none"> • Connector structure complying with RJ11 standard has four contacts. • Two telephone lines can be connected. • Green and red wires are used for the 1st line, and yellow and black wires for the 2nd line. 		
	Technical Specifications	Data Socket (RJ45)	Circuit Diagram
	<ul style="list-style-type: none"> • RJ45 connector complying with standards EIA/TIA 568 A and B • Pins on it have been marked according to both 568 A and 568 B standards. 		
	Technical Specifications	British Type Phone Socket	Circuit Diagram
	<ul style="list-style-type: none"> • Pins on it have been marked according to both 431A and 631A standards. 		

Technical Drawings and Circuit Diagrams



Technical Specifications

USB Connector

Circuit Diagram

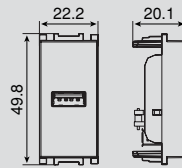

Technical Specifications

TV Socket

Circuit Diagram

Shielded. Shielded, does not get affected by airborne radio signals.

- Screw type mounting.

TV Socket, Through-pass

Used for broadcast distribution to multiple TV receivers where broadcast is received from UHF/VHF bands to the center via an antenna system and then distributed via inter-socket or inter-floor -in multi-storey buildings- transition.

TV Socket, Terminated

Used in star-connected systems for Internet, cable TV or central satellite broadcasts. May also be used at the end of the shared antenna systems.

TV Socket, Lossless

Used with independent Internet, cable TV or satellite broadcasting systems, and independent antennas.

- The sockets to be mounted after the amplifier must be 12 dB and 8 dB through-pass, terminated and lossless options to be compatible with 60-85 dBuV TV signal levels.

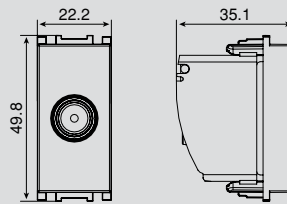

TV Socket (Through-pass)				
Frequency range (f/MHz)	5 MHz	860 MHz	950 MHz	1000 MHz
IN-OUT (DB)	3,5	3,5	3,5	3,5

TV Socket (Terminated)				
Frequency range (f/MHz)	5 MHz	860 MHz	950 MHz	1000 MHz
IN-OUT (DB)	1,6	1,7	1,8	2,0
IN-TAP (DB)	15	15	15	15,5

TV Socket (Lossless)				
Frequency range (f/MHz)	5 MHz	860 MHz	950 MHz	1000 MHz
IN-TAP (DB)	3,5 dB	3,5 dB	3,5 dB	3,5 dB
IN-OUT (DB)	3,5 dB	5 dB	5 dB	5 dB



Technical Specifications

Satellite Socket with F Connector

Circuit Diagram

Used for receiving broadcast from the cable TV and UHF/VHF bands, and satellite.

Satellite Socket with F Connector, Through-pass

Used for broadcast distribution to multiple TV receivers where broadcast is received from UHF/VHF bands to the center via an antenna system and then distributed via inter-socket or inter-floor -in multi-storey buildings- transition.

Satellite Socket with F Connector, Terminated

Used in star-connected systems for Internet, cable TV or central satellite broadcasts. May also be used at the end of the shared antenna systems.

- The sockets to be mounted after the amplifier must be (10dB) transitive and terminated options to be compatible with 60-85 dBuV TV signal levels.

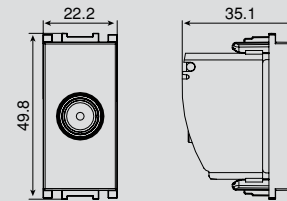

TV - SAT (Through-pass)									
Frequency range (f/MHz)	5 MHz	860 MHz	950 MHz	1000 MHz	1,2 GHz	1,6 GHz	2,0 GHz	2,25 GHz	2,4 GHz
SAT IN-OUT (DB)	≤ 11,5	≤ 11,5	≤ 11,5	≤ 12	≤ 12,5	≤ 14	≤ 14	≤ 14	≤ 14,5
TV IN-OUT (DB)	≤ 3,5	≤ 3,5	≤ 3,5	≤ 3,5					

SAT (Terminated)									
Frequency range (f/MHz)	5 MHz	860 MHz	950 MHz	1000 MHz	1,2 GHz	1,6 GHz	2,0 GHz	2,25 GHz	2,4 GHz
SAT IN-OUT (DB)	≤ 3,5	≤ 3,5	≤ 3,5	≤ 3,5	≤ 3,5	≤ 3,5	≤ 3,5	≤ 3,5	≤ 3,5



Technical Specifications

TV-SAT Socket

Circuit Diagram

- Shielded. Shielded, does not get affected by airborne radio signals.

- Used for receiving broadcast from the Internet, interactive applications, cable TV, and UHF/VHF bands.

TV-SAT Socket, Through-pass

Used for broadcast distribution to multiple TV receivers where broadcast is received from UHF/VHF bands to the center via an antenna system and then distributed via inter-socket or inter-floor -in multi-storey buildings- transition.

TV-SAT Socket, Terminated

Used in star-connected systems for Internet, cable TV or central satellite broadcasts. May also be used at the end of the shared antenna systems.

- The sockets to be mounted after the amplifier must be (8dB and 11dB) transitive and terminated options to be compatible with 60-85 dBuV TV signal levels.

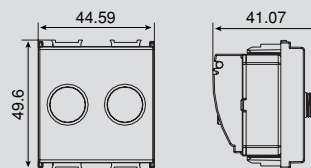

TV - SAT (Through-pass)									
Frequency range (f/MHz)	5 MHz	860 MHz	950 MHz	1000 MHz	1,2 GHz	1,6 GHz	2,0 GHz	2,25 GHz	2,4 GHz
SAT IN-OUT (DB)	≤ 3,5	≤ 3,5	≤ 3,5	≤ 3,5	≤ 3,5	≤ 3,5	≤ 3,5	≤ 3,5	≤ 3,5
TV IN-OUT (DB)	≤ 3,5	≤ 3,5	≤ 3,5	≤ 3,5					

TV - SAT (Terminated)									
Frequency range (f/MHz)	5 MHz	860 MHz	950 MHz	1000 MHz	1,2 GHz	1,6 GHz	2,0 GHz	2,25 GHz	2,4 GHz
SAT IN-OUT (DB)	≤ 11,5	≤ 11,5	≤ 11,5	≤ 12	≤ 12,5	≤ 14	≤ 14	≤ 14	≤ 14,5
SAT IN-TAP (DB)	≤ 2,5	≤ 2,5	≤ 2,5	≤ 2,5	≤ 3	≤ 3,8	≤ 4,5	≤ 5	≤ 5,5
TV IN-OUT (DB)	≤ 1,6	≤ 1,7	≤ 1,8	≤ 2,0					
TV IN-TAP (DB)	≤ 15	≤ 15	≤ 15	≤ 15,5					

Technical Drawings and Circuit Diagrams



Technical Specifications

HDMI Connector

Circuit Diagram

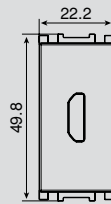

Technical Specifications

VGA Connector

Circuit Diagram

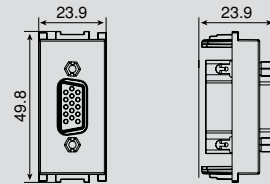

Technical Specifications

VGA Connector (PCB)

Circuit Diagram

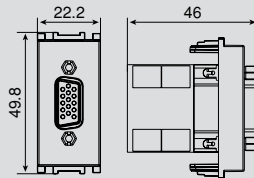

Technical Specifications

RCA Connector

Circuit Diagram

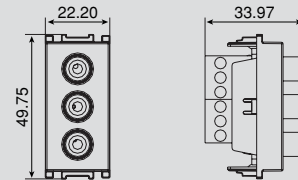

Technical Specifications

Volume Control Switch with Transformer

Circuit Diagram

- 11-grade sound adjustment
- 2VA transformer
- Suitable for systems with line transformer
- 4x100W speakers with line transformer
- Suitable for deep cases
- Built-in relay unit for 100V sound systems and emergency announcements.

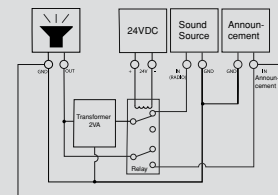
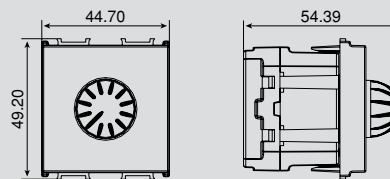

Technical Specifications

Audio Channel Selection Switch

Circuit Diagram

- 5 channel selection

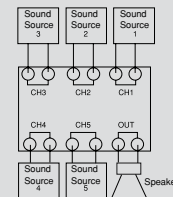
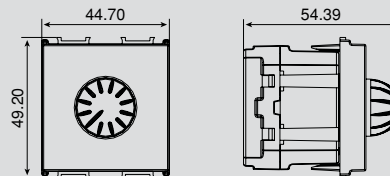

Technical Specifications

Audio Socket

Circuit Diagram

- 11-grade sound adjustment
- 3-1200 Ω
- Suitable for shallow cases
- 5W speaker input
- 8Ω resistant volume control

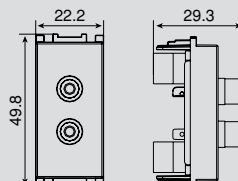

Technical Drawings and Circuit Diagrams

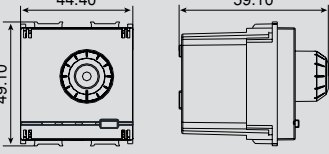
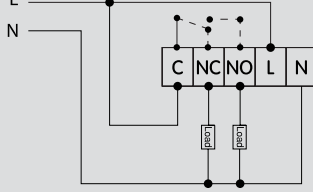
📄	Technical Specifications	Analog Thermostat	Circuit Diagram
	<ul style="list-style-type: none"> • 230V~, 50/60Hz • Maximum output current: * Changeover/normally open contact NO: 10(4)A 230VAC * Changeover/normally closed contact NC: 5(2)A 230VAC • Temperature control range of $\pm 1^{\circ}\text{C}$ between $+10^{\circ}\text{C}$...$+30^{\circ}\text{C}$ • Shortest switching time 5 minutes • Operating temperature 0°C...$+30^{\circ}\text{C}$ • Complies with standards EN 60730-1 and EN 60730-2-9 		

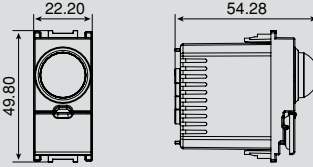
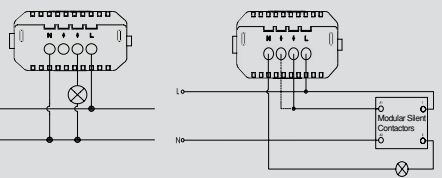
📄	Technical Specifications	Motion Detector	Circuit Diagram
	<ul style="list-style-type: none"> • 230V~, 50/60Hz • 180° horizontal sensing angle • Time setting from 10 seconds to 20 minutes • Operating temperature 0°C...$+35^{\circ}\text{C}$ • Assembly height between 1m and 2m • Suitable for usage with loads at the range of 50W/VA - 300W/VA • Daylight setting between 5 lux - 250 lux values • Not for use with LED, Fluorescent or CFL type Lamps 		

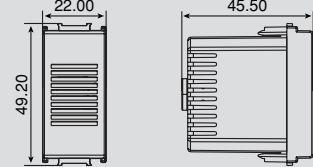
📄	Technical Specifications	Buzzer (Ding-Dong)	Circuit Diagram
	<ul style="list-style-type: none"> • 230V~, 50/60Hz • 85dB minimum sound volume 		

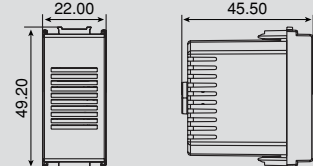
📄	Technical Specifications	Buzzer	Circuit Diagram
	<ul style="list-style-type: none"> • 230V~, 50/60Hz • 85dB minimum sound volume 		

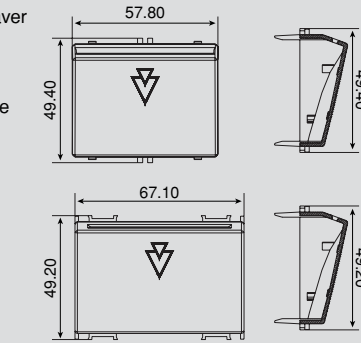
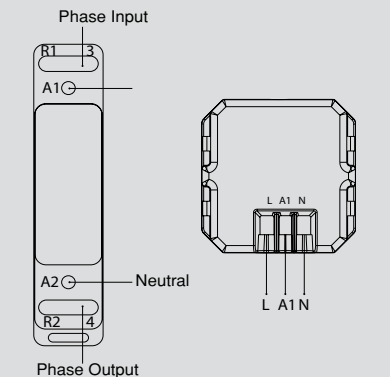
📄	Technical Specifications	Energy Saver Mechanical Switch 230V	Circuit Diagram
	<ul style="list-style-type: none"> • When a proper card is inserted into Energy Saver reader slot, it sends energy to relay coils to activate the electricity in the room. • When the card is removed from the slot, room electricity is cut within 15 ± 3 seconds. When the card is inserted into its slot, pilot lighting LED goes off. • 250V~ operating voltage • 0.5A maximum switching current • Minimum diameter of connection cable is $0,50\text{mm}^2$, maximum length is 25m • 15 ± 3 seconds shutting down delay • Complies with standard EN60669-2-1 • Suitable for usage with all card types • The product Energy Saver Mechanical Switch 220V can only be used with suitable contactors. 		

Technical Drawings and Circuit Diagrams



Technical Specifications

Energy Saver Mechanical Switch 5V

Circuit Diagram

- When a proper card is inserted into Energy Saver reader slot, it sends signal to relay unit to activate the electricity in the room.
- When the card is removed from the slot, room electricity is cut within 15 ± 3 seconds. Delay is made by relay unit. When the card is inserted into its slot, pilot lighting LED goes off (if LED is still on, it means that the card isn't sensed).
- 5V operating voltage
- 16A maximum switching current
- Minimum diameter of connection cable is $0,50\text{mm}^2$, maximum length is 25m
- 15 ± 3 seconds shutting down delay
- Complies with standard EN60669-2-1
- Suitable for usage with all card types
- The product Energy Saver Mechanical Switch 5V is suitable for usage with ESCU type relay.
- Connection cables between energy saver card reader and relay unit should be spanned within a different channel away from indoor 230V installation cables and cables with shielding feature should be used.

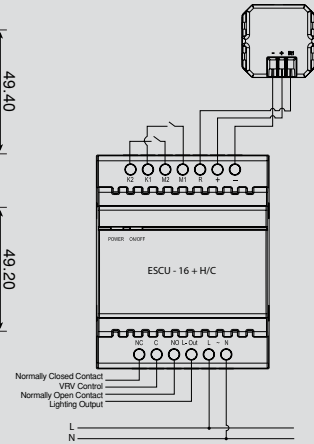
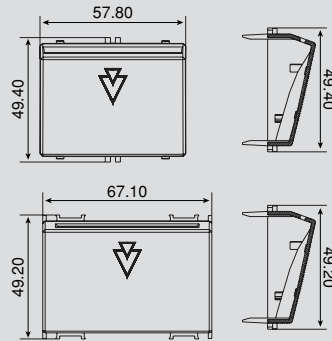

Technical Specifications

Energy Saver 13,56 MHz RF

Circuit Diagram

- When a proper card is inserted into Energy Saver reader slot, it sends signal to relay unit to activate the electricity in the room.
- When the card is removed from the slot, room electricity is cut within 15 seconds. Delay is made by relay unit. When the card is inserted into its slot, pilot lighting LED goes off (if LED is still on, it means that the card isn't sensed).
- 5V operating voltage
- 16A maximum switching current
- Minimum diameter of connection cable is $0,50\text{mm}^2$, maximum length is 25m
- 15 ± 3 seconds shutting down delay
- Complies with standard EN60669-2-1
- Suitable for usage with cards complying with standard ISO/IEC 14443A
- The product Energy Saver 13,56 MHz RF is suitable for usage with ESCU type relay.
- Connection cables between Energy Saver card reader and relay unit should be spanned within a different channel away from indoor 230V installation cables and cables with shielding feature should be used.

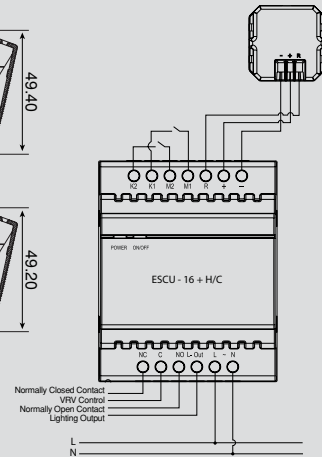
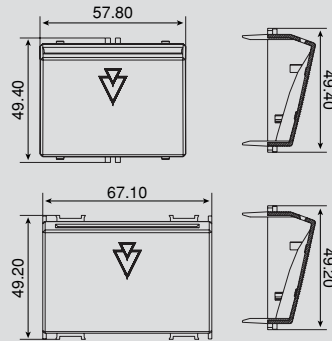

Technical Specifications

Do not Disturb/Make-up Room Indicator

Circuit Diagram

- 230V~
- 2,5W power consumption

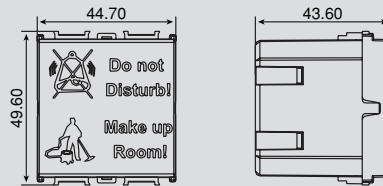

Technical Specifications

Direction Indicator - Arrow

Circuit Diagram

- 230V~
- 2,5W power consumption

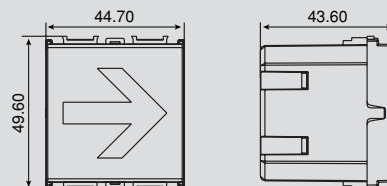

Technical Drawings and Circuit Diagrams

Technical Specifications

- 230V~
- 2,5W power consumption

Direction Indicator - Warning

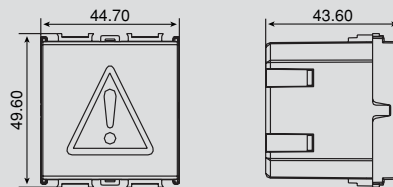

Circuit Diagram

Technical Specifications

- 230V~
- 2,5W power consumption

Direction Indicator - Exit

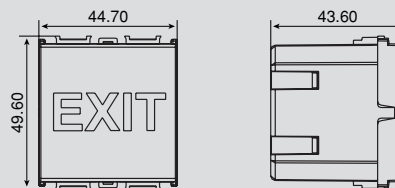

Circuit Diagram

Technical Specifications

- 230V~
- 2,5W power consumption

Direction Indicator - Male/Female

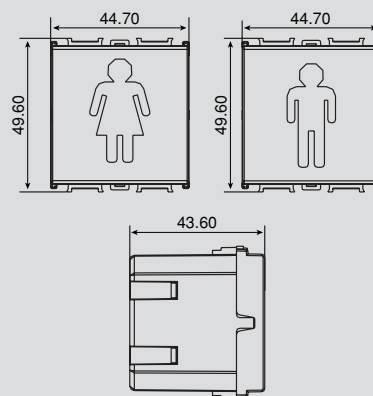

Circuit Diagram

Frame Dimensions

Ultima 2M Frame

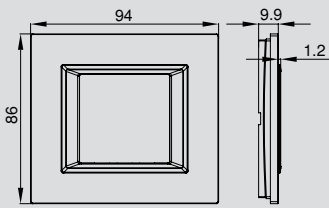

Ultima 2x2M Frame

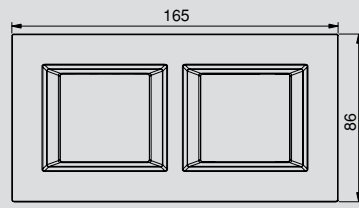

Ultima 3M Frame

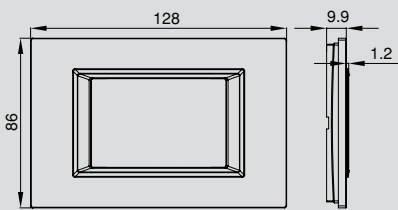

Ultima 3x2M Frame

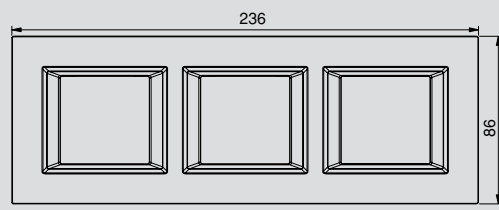

Ultima 4M Frame

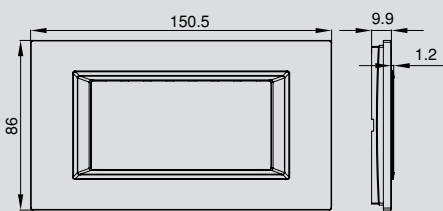

Ultima 4x2M Frame

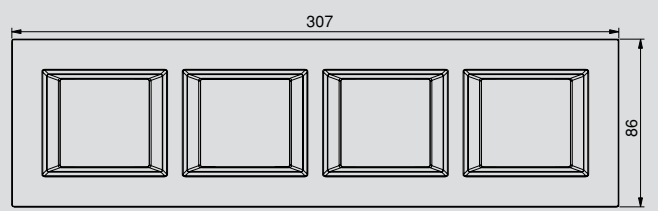

Ultima 7M Frame

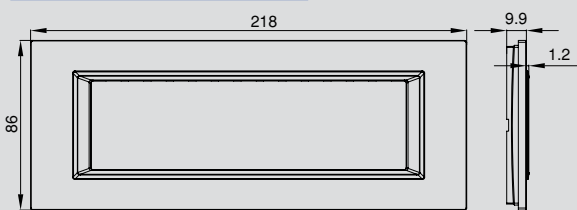

Frame Dimensions

Sistema 2M Frame

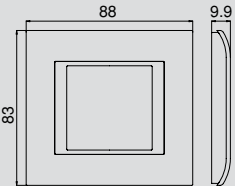

Sistema 2x2M Frame

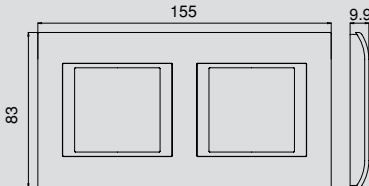

Sistema 3M Frame

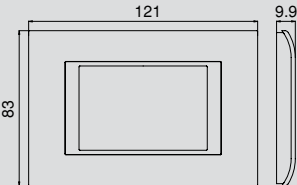

Sistema 3x2M Frame

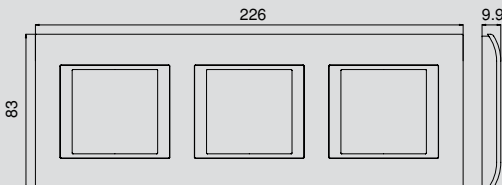

Sistema 4M Frame

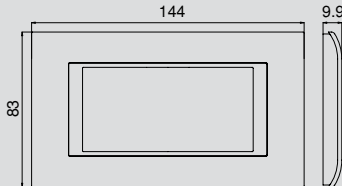

Sistema 4x2M Frame

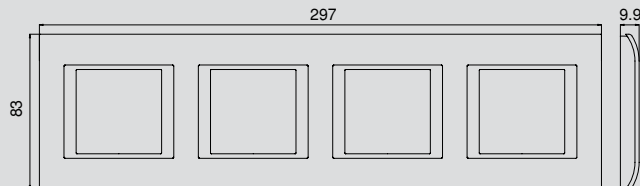

Sistema 7M Frame

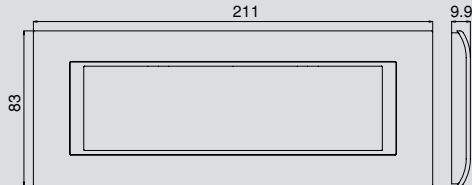

Frame Dimensions

Optima 2M Frame

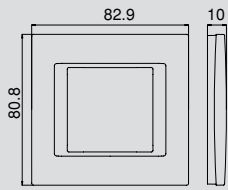

Optima 2x2M Frame

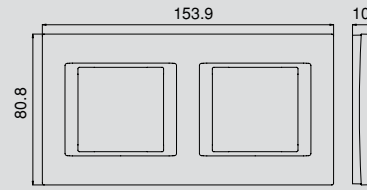

Optima 3M Frame

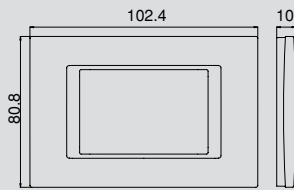

Optima 3x2M Frame

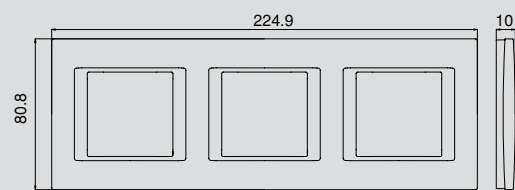

Optima 4M Frame

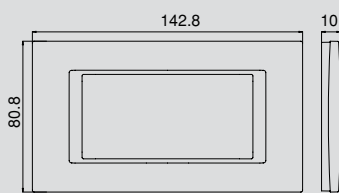

Optima 4x2M Frame

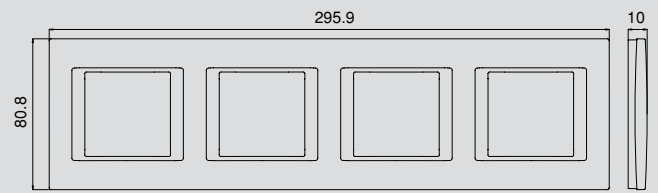

Optima 7M Frame

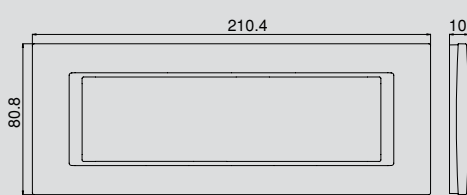

IP55 Frame

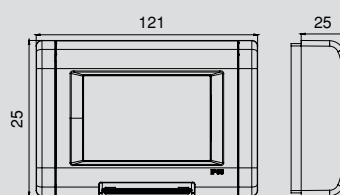

Wall Box Dimensions

Hallow Wall Box 2M

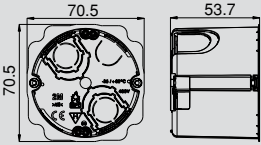

Wall Mount Box 2M

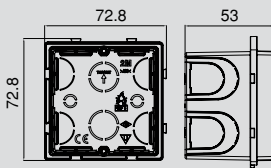

Hallow Wall Box 3M

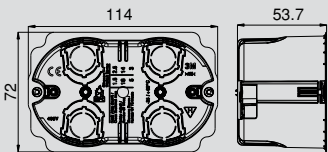

Wall Mount Box 3M

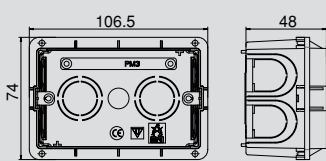

Hallow Wall Box 4M

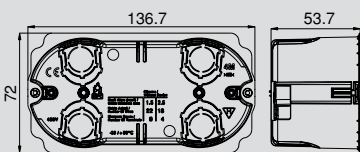

Wall Mount Box 4M

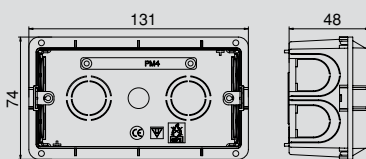

Hallow Wall Box 7M

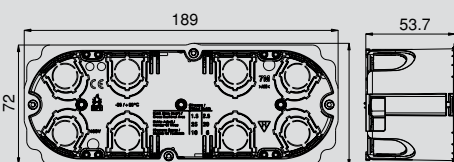

Wall Mount Box 7M

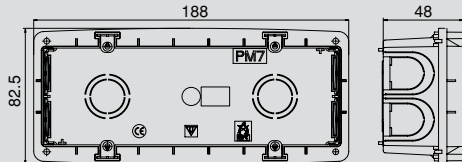

Mounting Frame Dimensions

Mounting Frame 2M

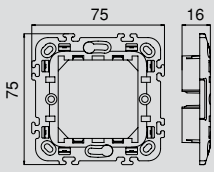

Metal Mounting Frame 2M

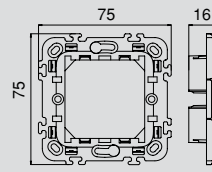

Mounting Frame 3M

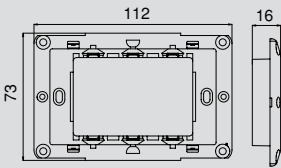

Mounting Frame 4M

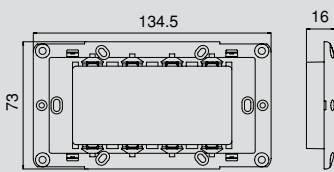

Mounting Frame 7M

